



ROYAL

HOW TO INSTALL

VINYL SIDING



Royal Building Products
Where Great Ideas Take Shape

siding, SOFFIT AND ACCESSORIES

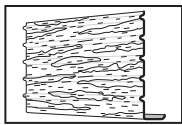

Vinyl Fascia

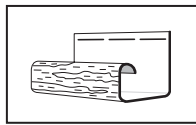

5/8" J-Channel

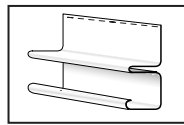

Frieze Trim

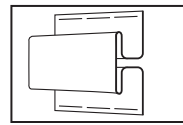

T-Trim Matte

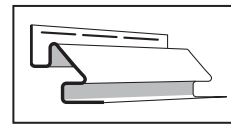

5/8" Inside
Corner Matte

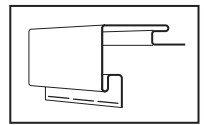

5/8" Outside
Corner Post

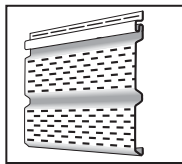

Double 5 Soffit
Vented

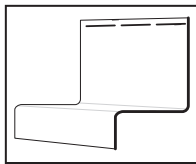

Drip Cap

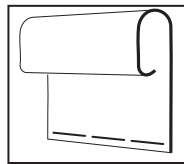

Finish Trim

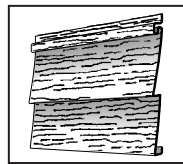

Double 4
Traditional

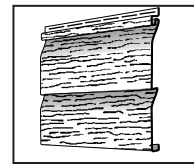

Double 5 Dutchlap

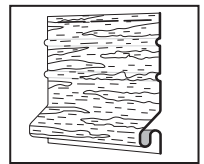

Starter Strip

what DO YOU NEED?

Accessories	Starter Strip	Outside Corner Post	Inside Corner Post	Drip Cap	Finish Trim	J-Channel	Vertical Base Flashing	Frieze Trim
Horizontal Siding	Yes	Yes	Yes	Yes	Yes	Yes	No	No
Vertical Siding	No	Yes	Yes	Yes	Yes	Yes	Yes	No
Soffit	No	No	No	No	No	Yes	No	Yes
Vinyl Fascia	No	No	No	No	Yes	No	No	No

how TO MEASURE

Use these handy guidelines when measuring your home:

area of a rectangular wall = height x width

HORIZONTAL SIDING

Increase the height to make it divisible by the width of the siding panel (e.g. 20.3 cm (8") with Double 4" profile). For example, if your wall is 114", you must add 6" to your estimate to ensure you buy enough vinyl siding.

VERTICAL SIDING

Increase the width to make it divisible by the width of the vertical siding panel being used.

GABLE ENDS

Use the following formula: area of a gable end = height x max. width divided by 2 (add 10% for waste)

DOORS AND WINDOWS

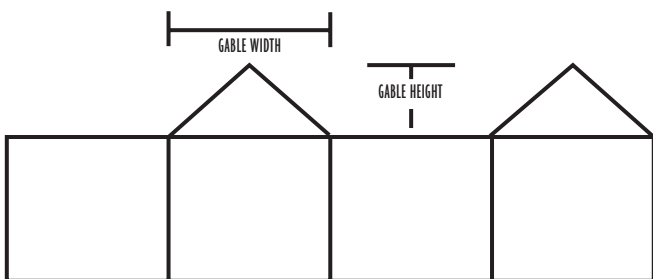

Measure all large openings and subtract from gross wall area.

IMPORTANT FIRE SAFETY INFORMATION

When rigid vinyl siding is exposed to significant heat or flame, the vinyl will soften, sag, melt or burn, which may cause or contribute to damage or injury. Care must be exercised when selecting underlayment materials because many underlayment materials are made from organic materials that are combustible. All building materials should be installed in accordance with local, state and federal building code and fire regulations.

how much IS NEEDED?

Enter your home's measurements to estimate the materials you require.

WALLS

Front & Left Side
Height x Width

____ x ____ = _____

____ x ____ = _____

____ x ____ = _____

____ x ____ = _____

Back & Right Side
Height x Width

____ x ____ = _____

____ x ____ = _____

____ x ____ = _____

____ x ____ = _____

GABLES

Height x Width ÷ 2

____ x ____ ÷ 2 = ____

____ x ____ ÷ 2 = ____

____ x ____ ÷ 2 = ____

Height x Width ÷ 2

____ x ____ ÷ 2 = ____

____ x ____ ÷ 2 = ____

____ x ____ ÷ 2 = ____

OPENINGS

Height x Width

____ x ____ = _____

____ x ____ = _____

____ x ____ = _____

____ x ____ = _____

____ x ____ = _____

____ x ____ = _____

____ x ____ = _____

Height x Width

____ x ____ = _____

____ x ____ = _____

____ x ____ = _____

____ x ____ = _____

____ x ____ = _____

____ x ____ = _____

____ x ____ = _____

SOFFIT

Width: _____

Front: _____

Side: _____

Rear: _____

Side: _____

FASCIA

Width: _____

Front: _____

Side: _____

Rear: _____

Side: _____

Total Walls and Gables _____

add 10% for loss _____

subtract openings _____

Net Total Siding _____

Total Soffit _____

Total Fascia _____

getting STARTED

Each step of this installation guide has been designed to make installation quick and easy. You may encounter alternative techniques you are not familiar with, so we recommend that you consult a Royal Building Products representative first to ensure a successful installation.

Important: Please read through all the instructions before you begin.

tool CHECK LIST

- work table
- ladders and/or scaffolding
- radial saw*
- tape measure
- chalkline
- square
- level
- hammer
- utility knife
- tin snips
- caulking gun

* You may use a fine blade circular saw if you reverse the blade for a smooth cut.

SPECIAL TOOLS (available from your dealer)

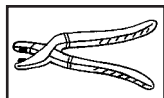

snap-lock punch

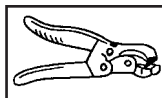

nail-slot punch

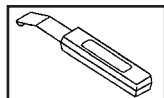

zip tool

ZIP TOOL USAGE

To disengage a locked panel, simply hook the zip tool to the lock. Pull gently downwards and continue moving along the panel until the entire overlapping panel is unlocked. You may also use the zip tool to engage a lock.

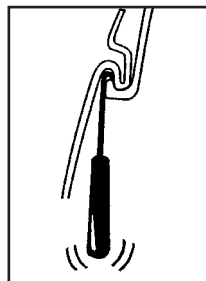

preparation FOR HORIZONTAL VINYL SIDING

NEW CONSTRUCTION

- 1) Make sure all studs are straight and true. Correct any bowed studs.

Note: Vinyl siding must be applied over a rigid sheathing that provides a smooth, flat surface or an underlayment (such as wood, wood composition, rigid foam or fiber sheathing). Vinyl siding cannot be applied directly to studs.

- 2) Make sure sheathing is fastened securely to studs.
- 3) If you're planning to use a conventional house wrap or building felt, apply according to the manufacturer's recommendations. In all cases, however, install the products so they are secured firmly to the substrate so that they provide a smooth, even surface for the final siding installation.
- 4) Before applying siding make certain substrate is watertight.

(In order to be properly protected from precipitation, the substrate may need to be properly flashed around areas such as windows, doors, other openings and corners so as to shed water to the exterior. The siding alone is not meant to be a watertight barrier.

Note: Failure to establish a smooth, solid surface constitutes misapplication under the terms of the warranty.

basic rules OF VINYL SIDING APPLICATION

- 1) Do not nail tightly. Allow a minimum of 1/16" between the back of the nail head and the nailing strip. Nails should penetrate a minimum of 1" into a solid nailable surface and be no more than 16" apart. All panels should slide free, horizontally, after nailing.
- 2) Always nail in the center of the slot. **WARNING:** Do not nail at the end of a slot! Doing so will cause the siding panel to be permanently damaged. If you must nail near the end of a slot to hit a stud, etc., extend the length of the slot with a nail slot-punch tool.
- 3) DO NOT FACE NAIL.

- 4) Leave a minimum of 1/4" clearance at all openings and accessory channel stops to allow for normal expansion and contraction. In cold weather (below freezing) leave 3/8" minimum clearance.
- 5) Do not stretch horizontal siding panels upward when applying. Instead, push upward on the bottom of the panel you are installing until the locks fully engage. Nail in place. Panels should hang without strain after nailing. Stretching the panel upward pulls the natural radius out of the panel and increases friction of the locks.
- 6) When installing shutters, cable mounts, etc., make sure the screw hole in the siding is 1/4" larger than the attachment screw diameter (example: an 1/8" screw requires a 3/8" hole in the siding). This will allow panel to expand and/or contract.

NAILS

Use only corrosion-resistant nails (aluminum nails or galvanized roofing nails) with a minimum head diameter of 3/8".

To determine length of nail required, measure thickness of sheathing material. Then add 1" to sheathing thickness. The minimum nail size should be 1 1/2".

installing ACCESSORIES

SNAPPING A CHALK LINE

If the house is reasonably level, find the lowest point of old siding (or sheathing if working on new construction). Partially drive a nail at one corner, 2 1/4" above lowest corner. Attach chalk line. Go to the other corner and pull chalk line tight. Stretch the chalk line from this nail to the opposite corner of the house. Make sure the line is level using a line level or 2' (minimum) level. Snap chalk line and repeat procedure around entire house.

Note: If after establishing a chalk line you find that your starter strip will be positioned below an easily nailed surface, you may have to apply a nailable base.

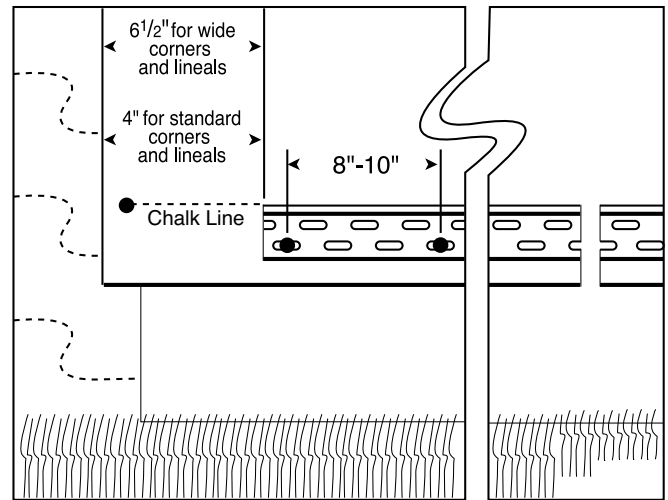

INSTALLING THE STARTER STRIP

Position starter strip with the top edge on the chalk line and the ends 6 1/2" away from the outside and inside corners when using lineal systems or wide corners, 4" if using standard one piece corners.

Nail to wall following previously mentioned nailing instructions making sure to nail every 8" to 10" on center in the lowest nail slot available. When hollows occur in the wall surface, shim out the starter strip to avoid a wavy appearance in the finished siding job.

As you add starter strip sections, be sure to leave 1/4" space between them for expansion.

INSTALLING OUTSIDE CORNER POSTS

Position outside corner post with the top of the post 1/4" from the underside of the eave and the bottom of the corner post 3/4" below the starter strip. Remove the bottom 3/4" of the nailing flange so it will not show below the siding when installed.

Make sure posts are straight and true before nailing. Hang corner posts by first positioning a nail at the top of the top-most nail slot. Position all remaining nails in the center of nail slots a maximum of every 10". This nailing pattern is to be followed on both nail flanges of each post.

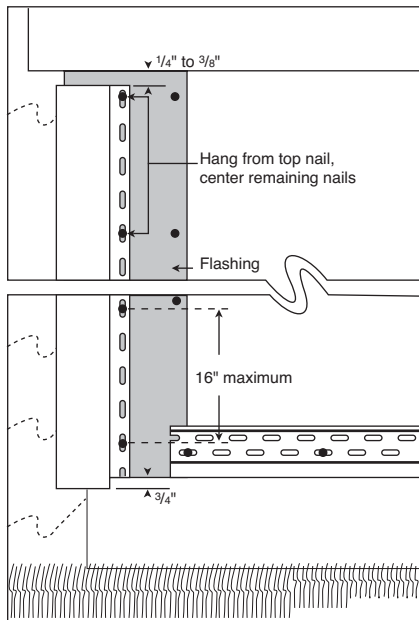

Lapping of outside corner posts

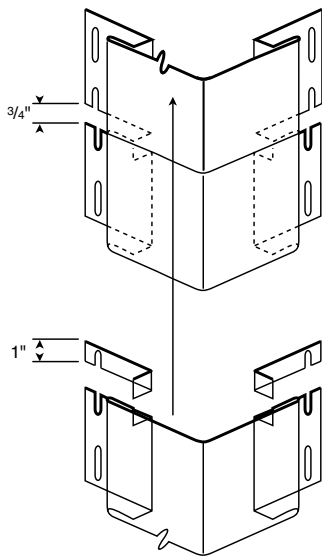

If posts must be spliced for high walls, cut 1" off the nailing flanges and back from the bottom portion of the upper post. Then lap 3/4" of the upper post over the lower post, allowing 1/4" for expansion. This method will provide an obvious joint between the two posts but will allow water to flow over the joint, reducing the chance of water infiltration (shown above).

INSTALLING TRIM AT ROOF LINE

At points where vinyl siding and accessories will meet at a roof line such as areas where a gable dormer or a second-story side wall intersect with the roof, it's best to position the J-channel so it's 3/4" to 1" away from the roof line. Placing the J-channel directly on the roof line would subject it to a build-up of heat, which could result in excessive expansion. To prevent water infiltration along the intersection of roof and wall, install flashing before installing J-channel.

Note: If you use more than one length of J-channel to span a wall surface, be sure to overlap J-channels 3/4".

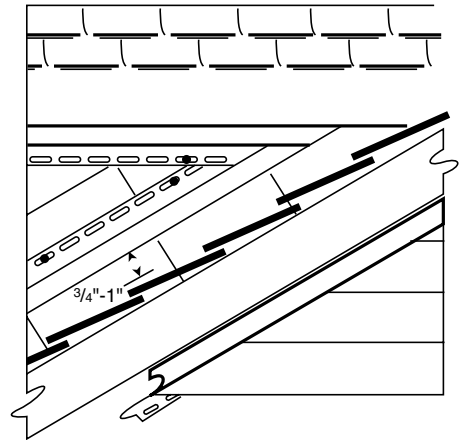

INSTALLING WINDOW AND DOOR TRIM

Install J-channel along top and sides of door casings and around windows.

(For best results, use aviation snips when cutting J-channel.)

Note: When installing J-channel around replacement windows that do not have nail flanges, add flashing for greater protection against water infiltration.

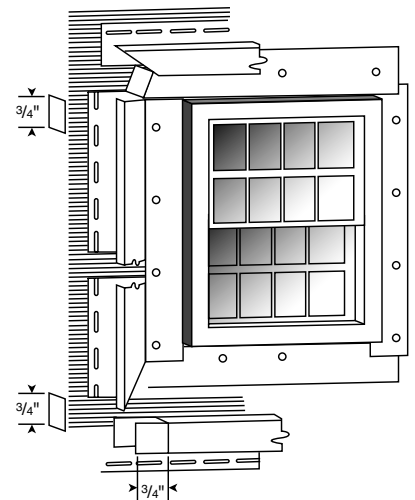

TO MITER CUT CORNERS

For best results, make sure you cut all J-channels to proper length, leaving the proper allowance for the width of the face of the J-channel.

- 1) Square cut bottom J-channel so that the ends extend beyond the window casing to the width of the face of the side J-channels. Notch ends for clearance. Position and nail.
- 2) Measure side J-channels, adding width of both the top and bottom J-channels. Miter cut (45° angle) lower ends of both side J-channels. Cut and bend water tabs, notch top of J-channel, position and nail.
- 3) Mark top J-channel so the ends extend beyond the casing to the width of the side J-channels. Miter cut (45° angle) ends. Cut and bend water tabs. Position and nail.

installing HORIZONTAL SIDING

INSTALLING THE FIRST COURSE

It's important to work with care and planning as you install siding panels. This is especially true when you're installing the first course of siding.

For best results, follow these guidelines:

- 1) The key to creating a visually attractive installation is to lap away from areas where people normally walk or gather. For example, on the front wall, work from the corners to the entrance door (so overlaps face away from door). On side walls, work from the rear corners toward the front. This approach minimizes the effect of lapping and produces the best appearance. Keep lap appearance in mind throughout installation.
- 2) Slide the first panel into the corner post recess. Leave room for expansion.
- 3) Hook the bottom lock of the panel into the interlock bead of the starter strip by applying upward pressure.
- 4) Before nailing, double-check to make certain you've locked the panel along its entire length. A slight upward pressure may be required to snap the interlock securely. Don't force the lock too tightly, however, you may distort your laps. Also make certain the panel can slide freely. Nail properly. Start at the center of the panel and work out.

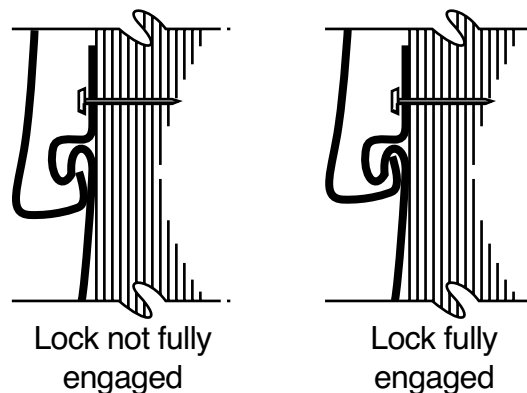

- 5) Install remaining starter course panels, overlapping panel ends 1". The last nail should be at least 4" from the end of the panel to allow for a neat lap.
- 6) Remember to leave room for expansion when fitting panels into remaining inside and outside corner posts.

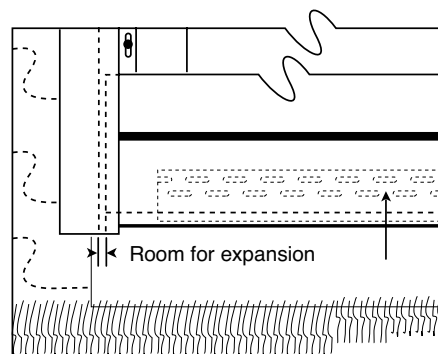

INSTALLATION OF REMAINING COURSES

To assure best appearance, plan positioning to avoid unsightly joint patterns. The illustration on the next page shows a well-planned staggering of panel joints.

Follow these guidelines:

- 1) Separate joints by at least two courses.
- 2) Avoid joints above and below windows.
- 3) Leave at least 3' separating joints on successive courses.
- 4) Use short cutoff lengths for fitting at narrow openings between windows.
- 5) Follow the planned pattern when applying the next courses of siding.

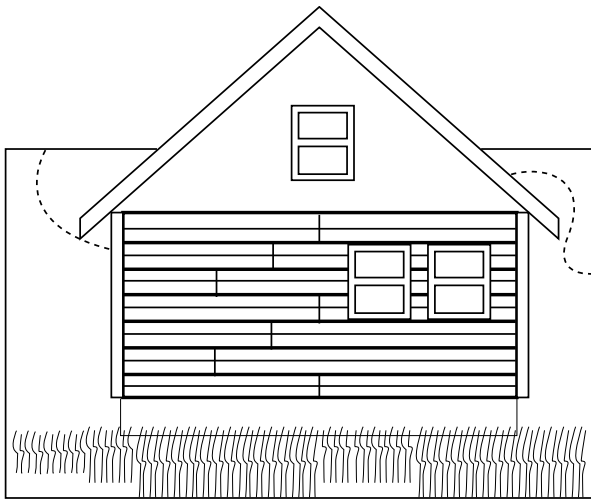

FITTING UNDER WINDOWS

- 1) Hold panel in place and mark width of window opening. Add $1/4"$ ($3/8"$ in weather below 40°F) to both ends to allow for expansion. The resulting marks show location of vertical cuts. Extend marks onto panel using square.
- 2) Create a template for horizontal cut using small piece of scrap siding. Lock this piece into lower panel and mark $1/4"$ below sill height. This provides clearance for undersill trim. Repeat procedure on opposite

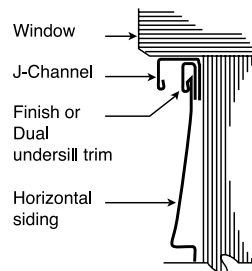
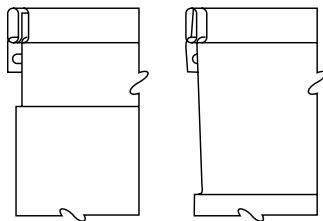
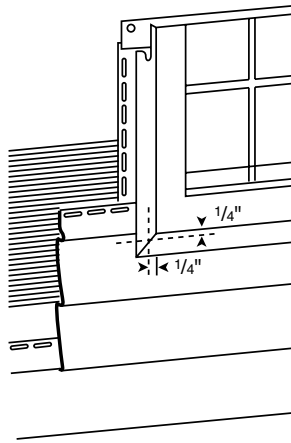

side of window (you can't assume windows will be perfectly level).

- 3) Transfer marks from template to panel. Connect marks using straight edge.
- 4) Cut panel using tin snips to make vertical cuts and utility knife to make horizontal cut.

Follow these steps to install panel :

- 1) If necessary to maintain slope angle, install furring under sill.

Note: You can eliminate this step by using dual undersill trim. Use the outer channel if the cut has been made near the butt edge or on the hip of designer profiles.

- 2) Use snap lock punch to raise tab faces on outside of panel. Punch out tab every 6".
- 3) Push horizontal edge of cut into finish trim. Slide vertical edges of cut into J-channels at window sides. Make certain installed panel locks into panel below.

Note: Finished trim must be installed inside a J-channel.

FITTING OVER WINDOWS AND DOORS

The procedure for cutting panels for installation over windows and doors is similar to that explained earlier.

When installing:

- 1) If necessary to maintain slope angle, install dual undersill trim above window or door as explained in "Fitting under windows" section.
- 2) Drop panel into position, making certain it fits into Finish Trim and J-channel at top and J-channels at sides. Interlock with siding panels below.

Note: Finished trim must be installed inside a J-channel.

FITTING UNDER SOFFIT

When you reach the last course of siding you will probably have to rip cut panels lengthwise to fit under soffit.

Note: If necessary to ensure proper panel slope angle, make certain to fur out this area as explained in "Fitting under windows" section.

1) Install J-channel and finish trim or dual undersill trim.

2) Measure from soffit to base of upper lock on previous course of panels. Subtract 1/4". Mark this dimension on panel to be cut, taking measurement from bottom edge of panel.

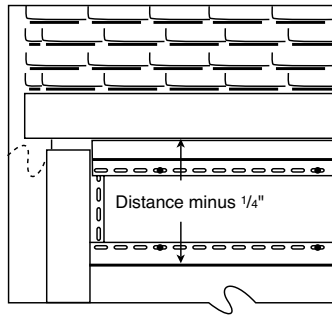

3) Using a square or straight edge, draw a pencil line connecting these points. Then score along line with utility knife. Bend panel back and forth until it snaps.

4) Use snap-lock punch to create tabs on outside face of panel, 1/4" below cut edge. Space tabs 6" apart.

5) To install, lock bottom of cut panel into panel below. Push top edge into finish trim. Tabs will catch in trim and hold panel firmly in place.

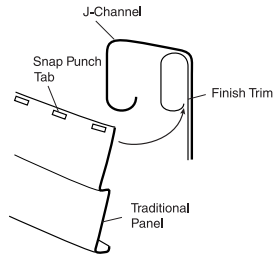

Note: Since you will not nail this last course, it is important that the tabs fit properly in finish trim to provide support while allowing movement for expansion.

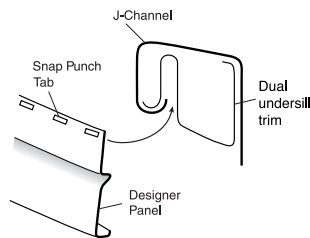

installing VERTICAL SIDING

PREPARING WALL SURFACES

For the most part, the wall preparation instructions given for horizontal siding also apply to vertical siding. The key requirement, of course, is that you start with a smooth, level and rigid substrate allowing for 1" nail penetration (plywood, wood composite, rigid foam or fiber sheathing).

INSTALLING CORNER POSTS

Install outside and inside corner posts using dimensions and procedures described earlier.

INSTALLING TOP AND BOTTOM J-CHANNEL

Apply J-channel along the top and bottom of the walls to receive the siding panels

1) Install the bottom J-channel (see illustration 1a). Overlap J-channels 3/4" (see illustration 2b). To do this, cut out a 1" section of the nailing flange and face return (see illustration 2a). Drill 1/8" diameter weep holes no more than 24" apart for water to escape.

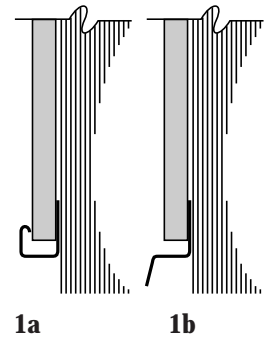

2) Install inverted J-channel along the top of the wall, under the eave. Nail in the center slots every 8" to 10" leaving a 1/4" gap between J-channel and corner posts. Overlap J-channels 3/4" to allow for expansion (see illustration 2b).

Note: If you're going to install soffit, you may want to install the receiving channels for the soffit at this point. The illustrations show alternative approaches for installing siding and soffit receiving channels.

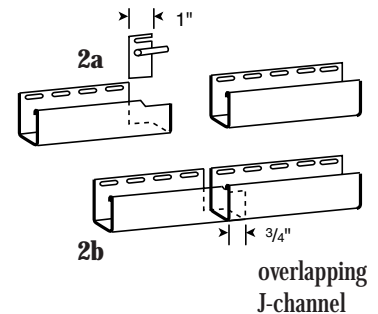

If a wall requires more than one course of siding, use two lengths of J-channel, back-to-back, at the joint between the two courses.

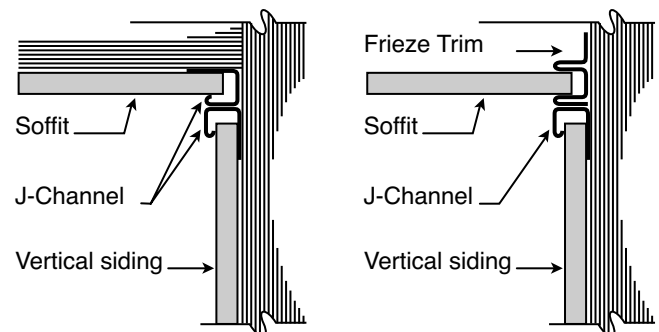

IF USING J-CHANNEL

Snap a chalk line parallel to the bottom J-channel, at a height equal to the length of the lower panel plus an allowance for expansion.

For example, if the lower panel is 144" long and you're adding 1/2" for expansion (because the temperature is above 40°F), you strike

a line 144 1/2" from the bottom J-channel. Nail inverted J-channels along this line to receive panels from below. Leave a 1/4" gap between J-channel and corner posts. Overlap J-channels 3/4".

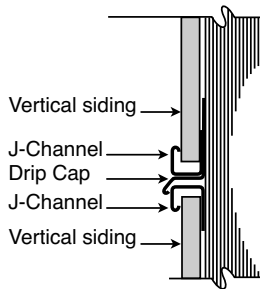

Prepare for the second course by applying head flashing above the just-installed J-channel. Then nail J-channel over the flashing to receive the upper panel. Drill 1/8" diameter weep holes no more than 24" apart for water to escape.

INSTALL WINDOW AND DOOR TRIM

Follow the instructions described earlier under "Installing window and door trim" on page 6.

PLAN THE PANEL LAYOUT

Correctly installed vertical siding should have a balanced appearance. This means that if you were to draw a vertical line down the center point of a wall, you'd have an equal number of panels to the right and left. If you had to trim panels to fit, the end-most panels would be of identical width.

To create this pleasing appearance, divide the space to be covered by a partial panel over both ends of a wall. For example, if a wall required 25 full panels plus 10", you would rip cut two 5" lengths of panel to create the end pieces.

Important!

In a vertical siding installation, most of the expansion is downward. So instead of allowing equal space for expansion at both ends of

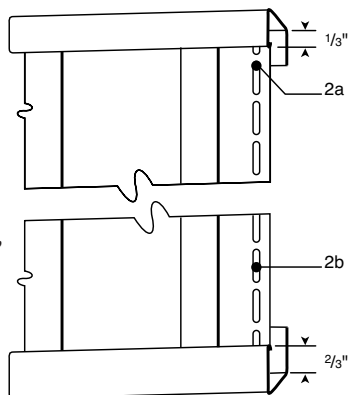

a vertical panel, leave more space at the lower end: allow for 1/3 of the total expansion at the top of a panel and 2/3 of the total expansion at the bottom. For example, if the total expansion equals 3/4" (3/8" + 3/8"), allow 1/4" at the top and 1/2" at the bottom.

Note: Always position top-most nail at the top of the top-most full nail slot (2a). Center remaining nails in the slots (2b) every 8" to 10".

INSTALLING WALL PANELS

- 1) Cut the first of the partial panels (if partial panels are necessary). Mark the cut line by measuring from the nail hem edge. Rip cut the panel. Do not cut off the nail hem. Use a snap-lock punch to create locking tabs along the cut edge. Space the tabs 6" apart.
- 2) Before installing this partial panel into the outside corner post, provide additional support at cut edge (to compensate for the locking channel that was trimmed off).

To do this, insert furring into the channel of the outside corner post and nail to substrate. After furring, insert a length of undersill trim into corner post and nail to furring. Finally, slide the cut edge of the panel into the undersill trim, making sure to engage the snap locks.

Using a level, make certain this panel is plumb. Nail every 12". Follow the same nailing procedures described for horizontal siding.

- 3) Install the next panel. Lock the panel into the preceding panel, then nail every 12". Check panel to make sure it is level then continue with succeeding panels.
- 4) When necessary, cut panels to fit around doors and windows. When marking the cut, remember to allow for expansion.

The method used to install panels around doors and

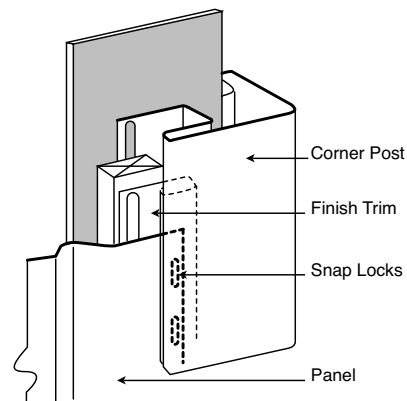

windows is determined by the need to cut a panel and the position of that cut. If a cut was made next to a remaining “V” groove, insert the panel into the J-channel. If a cut removes the support provided by a “V” groove, use the procedure described in step 2 above to provide support for the trimmed edge.

- 5) To finish the first course of a wall, cut the final panel to size and install in outside corner post, using method described in step 2.

Note: The cutting and supporting procedure described in step 2 is also used when fitting panels into inside corner posts.

installing SOFFIT AND FASCIA

INSTALLING TRIM - OPTION A

(When fascia is applied without exposed nailing)

Open soffit

Nail Frieze Trim to the exterior of the fascia with the top leg resting against the bottom of the board. Nail Frieze Trim on wall, level with Frieze Trim on fascia.

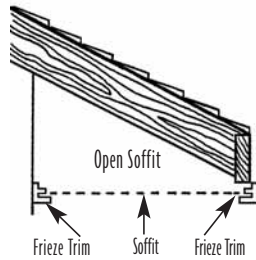

Closed soffit

Use a J-channel in place of the Frieze Trim at the wall. Nail all channels every 30 cm (12”) in the center of nailing slots.

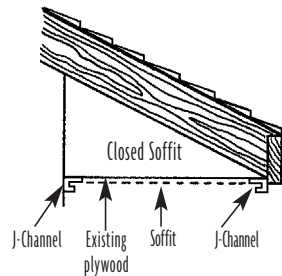

INSTALLING TRIM - OPTION B

(When fascia is nailed to underside of wood fascia or when applying soffit only)

Open soffit

Nail Frieze Trim to the wall and inside of the fascia board so they are level with each other.

Cut out back of channel to fit around rafters, if needed.

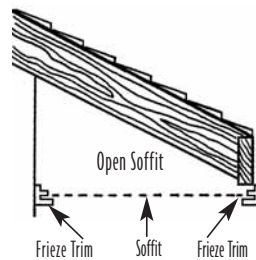

Closed soffit

Substitute J-channels for Frieze Trim. Nail all channels every 30 cm (12”) in the center of nailing slots.

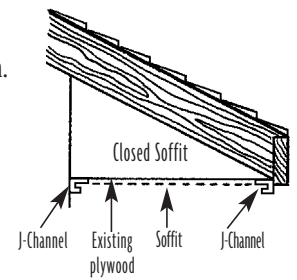

INSTALLING SOFFIT

- 1) Measure the distance between the inside of the two trims. Allow 6 mm (1/4”) space for expansion and cut the panels to this length. Insert soffit panels into the two trims.

Important: When installing soffit, intermediate nailing on 61 cm (24”) centers is needed when soffit width is over 61 cm (24”).

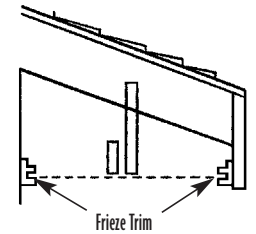

- 2) Interlock panels as you would for vertical siding. Closed soffit can be nailed every 30 cm (12”).

- 3) When fascia panel is not being applied, use a Frieze Trim or J-channel at corners of the overhang to properly finish the installation.

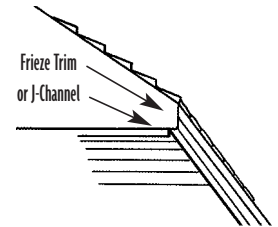

- 4) When two soffit sections meet (at corners) the joint can be either square or diagonal. Both methods utilize a J-channel or T-Trim. They should be properly supported and nailed back-to-back (or install a soffit T-Trim).

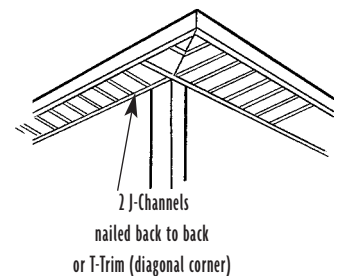
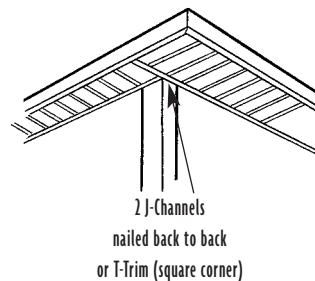

INSTALLING FASCIA

- 1) Install an undersill trim at the top of the outer face of fascia board.
- 2) Measure distance from the bottom of the Frieze Trim to the lower edge of the lock of the Finish Trim. If only fascia is being applied, measure to bottom of fascia board.
- 3) Add 1.9 cm (3/4") and cut panel to this width.

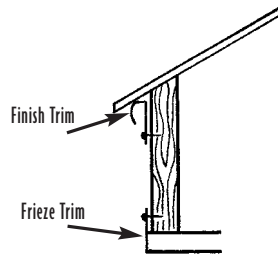

- 4) Perforate cut edge of the panel approximately every 20 cm (8") on center, using a snap-lock punch. Ensure punched "ears" face outward.

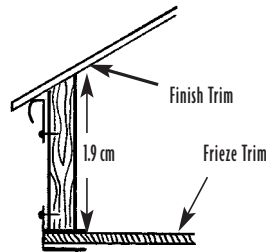

- 5) Hook the leg of the fascia panel over the bottom leg of the Frieze Trim, and snap the upper edge of the fascia into the Finish Trim. Use zip tool to help insert panel into undersill. If soffit is not being installed, fascia can be hooked directly onto board.

Important: If Frieze Trim was not used at the bottom of the fascia, insert panel into the undersill, hold it in place and drill a 3/16" hole through the bottom of fascia and soffit. Nail every 3" through center of hole into wood fascia to allow for expansion and contraction.

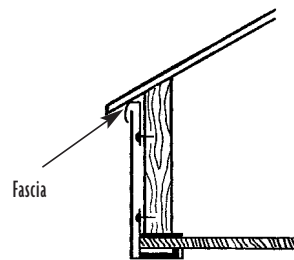

- 6) Fascia panels can be overlapped. Cut one panel as shown in shaded area and overlap half this amount. Only part of lower lip needs to be trimmed.

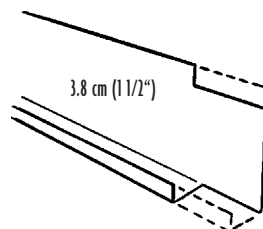

- 7) Trim corners by cutting lower lip off fascia or fascia panels to form a corner. Mark a vertical line on the panel where it will turn the corner. Cut a 90° section out of the bottom leg of the

panel and bend to form a right angle. To facilitate bending, the panel can be gently scored along the line.

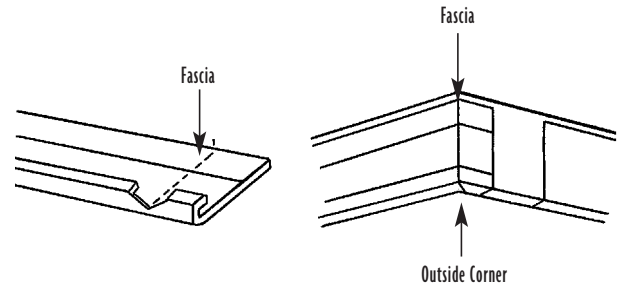

cleaning AND MAINTENANCE

To maintain your siding's beautiful appearance, wash the panels at least once a year using a sponge and a mild cleaning solution. If the dirt is hard to remove, wipe clean with a solution of:

- 1/2 cup laundry detergent (e.g. Tide)
- 2/3 cup Trisodium phosphate (e.g. Soilex)
- 1 gallon of water

Note: If mildew is a problem add 1 quart of liquid laundry bleach to this solution.

Important: Follow the precautionary labeling instructions on all cleaning agent containers. Protect eyes, skin and vegetation from direct contact with cleaning agents.

Staining agents	Cleaning agents	Preparation	Special Procedures
Light oils, grease, caulking compounds, wax, crayons, asphalt, tar, etc.	Solvents - mineral spirits V.M.P., Naphtha auto tar remover	Remove excess with plastic or wood scraper	Apply mineral spirits with soft cloth. Avoid using too much pressure to avoid polishing stained area. Rinse.
Markers, nail polish, lipstick, gum, and chalking	Cleaning fluid (trichloroethylene)	Remove excess with wood scraper. Chill gum to remove excess.	Apply cleaning fluid with soft cloth. Avoid using too much plastic or pressure to polish stained area. Rinse.
Rust stains	Oxalic acid - auto radiator cleaner	Make solution of 1 tablespoon of oxalic acid crystals to 1 cup of warm water.	Apply oxalic acid solution with soft brush, wipe up with damp cloth. Next, rinse with clean water.
Stubborn stains	Abrasive type cleaner, scouring pads, fine sandpaper.	Try above procedures (1-3)	Wet stains first. Rub agent in same direction as woodgrain. Do not remove more material than is necessary. Rinse.

ROYALLY COVERED

Year after year, season after season, Royal solid vinyl siding withstands the test of time. Engineered to earn the satisfaction of discriminating customers everywhere, Royal solid vinyl siding offers you peace of mind with the complete coverage of our Lifetime, Non-Prorated, Fully Transferable to Lifetime Non-Prorated Limited Warranty.



MEMBERSHIPS



APPROVALS / LISTINGS



ICBO
ER-4923

BOCA
99-29

SBCCI
9826A

TEXAS DEPT. OF
INSURANCE
EC-28

CCMC
LISTING
12244-L



MEA
233-92-M

VINYL SIDING
STANDARD
ASTM D3679

Dealer Stamp



Royal Building Products

Where Great Ideas Take Shape

www.royalbuildingproducts.com

000CR460IG 04/06